

# Operation Manual

## H100 Series High Performance Vector Control Mini Inverter





JIANGSHU DEODER ELECTRIC CO., LTD

---

Thank you for choosing H100 series multi-function and high-performance inverter.

Faulty operation of inverter during installation, wiring and operation may cause an accident, please read the Instruction Manual carefully before using so as to master correct using method, thus avoiding personal injury and property loss due to improper operation. After reading, please keep the Instruction Manual well for future maintenance, protection and application in other situations.

For your safety, please ask professional electrical engineering personnel to install and debug the inverter and adjust the parameters.

Signs like  危险 **DANGER** and  注意 **WARNING** in the Manual remind you of precautions when carrying, installing, operating and checking the inverter, please strictly follow the labeled warnings to realize the safety in use.

Refer to the Manual in case of any doubts; for the problems unsolved, please contact the Company directly or our distributors, we will assign professionals to serve you sincerely.

**Version No.: 1.0**

**Date: Jan 10, 2019**

**we always dedicated to perfecting the products and reserves the right to modify the Manual without notice.**

---

Safety level in the Manual refers to "danger" and "warning" with the signs respectively as below:



危险

**DANGER:** Casualties may be caused if failing to use as required.



注意

**WARNING:** Personal injury or damage to the inverter or mechanical system may be caused if failing to use as required.

Make sure the contents with safety signs are observed. For different situations, "Warning" may also cause serious results, so it is necessary to abide by the precautions in Instruction Manual.

---



危险

**DANGER**

- Turn the power off before wiring.
  - After cutting off AC power, high voltage still exists in the inverter before the charging indicator goes out, so it is dangerous to touch internal circuit and components.
  - Don't check the components and signal on circuit board during operation.
  - Don't dismantle or change the internal connection, wiring or components of inverter at will.
  - Don't control buttons with wet hands to avoid electric shock.
  - Earthing terminal of the inverter shall be grounded properly.
  - It is prohibited to change and replace the control panel and components at will so as to prevent electric shock, explosion and other dangers.
-



- Since semiconductor parts inside the inverter are easily damaged by high voltage, it is prohibited to perform voltage withstand test to them.
  - It is prohibited to connect the output terminal U.V.W of inverter to AC power.
  - Don't touch the inverter and brake resistor when the power is turned on or disconnected before long in high temperature, so as to avoid scalding.
  - Voltage applied to each terminal only can be that required in the Instruction Manual to prevent bursting, damage and so on.
  - Don't touch the main circuit boards CMOS and IC of the inverter since they are easily influenced and damaged by static electricity.
  - Only qualified professionals can install, debug and maintain the inverter.
  - Scrapped inverter shall be disposed as industrial wastes, and burning is prohibited.
  - After long-term storage, the inverter must undergo checking and commissioning before being used.
  - The inverter can be easily set for high-speed operation, before the setting, please check whether the characteristics of motor and machine are suitable for such high-speed operation.
-



---

## TABLE OF CONTENTS

|  |    |
|--|----|
| NO. 1 Safety cautions.....                               | 6  |
| 1.1 Unpacking inspection.....                            | 6  |
| 1.2 Installation.....                                    | 7  |
| 1.3 Use.....   | 8  |
| 1.4 Storage.....   | 8  |
| No. 2 Product introduction.....                          | 9  |
| 2.1 Specification of H100 sries.....                     | 9  |
| 2.2 General specification of the product.....            | 9  |
| No. 3 Wiring.....  | 12 |
| 3.1 Arrangement of main circuit terminals.....           | 12 |
| 3.2 Arrangement of control terminals.....                | 12 |
| 3.3 Description of main circuit terminals.....           | 12 |
| 3.4 Description of control terminals.....                | 13 |
| 3.5 Description of jumper function.....                  | 13 |
| 3.6 Basic wiring diagram.....                            | 15 |
| No. 4 Keyboard description.....                          | 17 |
| 4.1 Description of keyboard.....                         | 17 |
| 4.2 Description of indicator functions.....              | 18 |
| 4.3 Description of display items.....                    | 19 |
| No. 5 Function list.....                                 | 20 |
| 5.1 Basic function parameters.....                       | 20 |
| 5.2 Application function parameters.....                 | 21 |
| 5.3 Functional parameters of input/output terminals..... | 22 |
| 5.4 Functional parameters of analog quantity.....        | 26 |
| 5.5 Functional parameters of multi-segment speed.....    | 27 |
| 5.6 Protection function parameters.....                  | 30 |

---

|   |     |
|---|-----|
| 5.7 Function parameters of constant-pressure water supply.....  | 30  |
| 5.8 Motor function parameters.....                              | 31  |
| 5.9 PID function parameters.....                                | 32  |
| 5.10 Communication function parameters.....                     | 32  |
| 5.11 Monitoring function parameters.....                        | 33  |
| No. 6 Detailed function descriptions.....                       | 35  |
| 6.1 Basic function parameters.....                              | 35  |
| 6.2 Application function parameters.....                        | 40  |
| 6.3 Functional parameters of input/output terminals.....        | 46  |
| 6.4 Functional parameter of analog quantity.....                | 56  |
| 6.5 Protection function parameters.....                         | 59  |
| 6.6 Function parameters of constant-pressure water supply.....  | 67  |
| 6.7 Motor function parameters.....                              | 69  |
| 6.8 PID function parameters.....                                | 72  |
| 6.9 Communication function parameters.....                      | 75  |
| 6.10 Standard Modbus communication protocol.....                | 78  |
| No. 7 Maintenance and fault information.....                    | 91  |
| 7.1 Maintenance and inspection cautions.....                    | 91  |
| 7.2 Regular inspection items.....                               | 91  |
| 7.3 Fault information and fault clearing.....                   | 91  |
| 7.4 Fault and analysis.....                                     | 93  |
| 7.5 Common anomalies and countermeasures.....                   | 95  |
| No. 8 Selection and configuration of peripheral facilities..... | 96  |
| 8.1 Options.....  | 96  |
| 8.2 Configuration.....  | 97  |
| Annex I Examples of simple application.....                     | 99  |
| Annex II External and installation dimensions.....              | 102 |

---

## No.1 Safety cautions

### 1.1 Unpacking inspection

H100 series multi-function and high-performance inverter has passed test and quality inspection before delivery. After purchasing it and prior to unpacking, please check whether the package is damaged due to improper transportation, and whether the specification and model are in conformity with the ordered machine, in case of any problem, please contact the supplier.

#### 1. Inspection after unpacking

- (1) There is a inverter, an instruction manual, a warranty card and a certificate of approval inside.
- (2) Check the nameplate at side of the inverter to make sure the product in hand is the right one.

#### 2. Introduction of H100 series nameplate

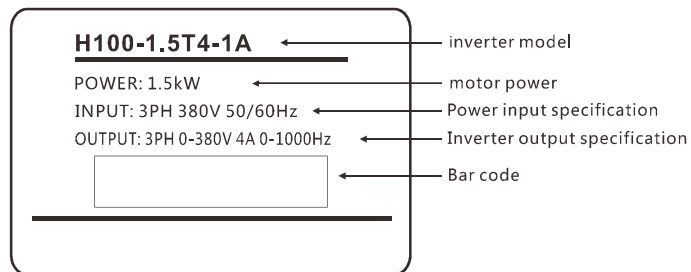

Figure 1-1 Introduction of H100 series nameplate

---

### 3. Model specification

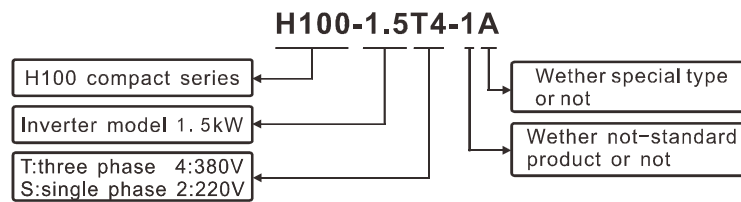

Figure 1-2 Inverter Model Specification

### 1.2 Installation

- Ambient temperature ranges from  $-5^{\circ}\text{C}$  to  $40^{\circ}\text{C}$ , high temperature and moist shall be prevented with the humidity less than 90% (non-condensation).
- Electromagnetic interference shall be prevented and interference source shall be kept away.
- Water drop, steam, dust, cotton dust, and metal powder, as well as oil, salt and corrosive gas shall be prevented entering.
- It is prohibited to install the inverter in environment with inflammable and explosive gas, as well as liquid and solid.
- It is unallowable to install air switch, contactor, capacitor or piezoresistor concerned and other devices at output side, so as to avoid inverter fault and damage to tripping protection or components.
- The inverter shall adopt independent power supply rather than sharing power supply with electric welder, so as to prevent the damage to inverter protection.
- To facilitate cooling and maintenance, the inverter shall be installed vertically with enough space around to ensure ventilation.
- Installation wall shall be made of non-combustible materials like iron plate which shall be prevented from vibration to cause damage to the inverter.
- If several inverters are installed up and down in one cabinet, certain spacing shall be kept and baffle plate shall be set there between.

---

## 1.3 USE

### 1.Before energizing

- Voltage of the power supply selected must have the same specification with the input voltage of inverter.
- PE refers to earthing terminal, please make sure the motor and inverter are grounded properly to ensure safety.
- Do not set contactor between power supply and inverter to control startup or stop of inverter, otherwise life time of the inverter will be impacted.
- Wiring of main circuit terminal shall be correct, L1.L2.L3.L.N refer to power input terminals which are prohibited to be mixed with U.V.W., otherwise, damage to the inverter may be caused during energizing.

### 2.Energizing

- It is prohibited to plug and unplug the connector on inverter to prevent surge entering the control panel and causing damage to the inverter.
- It is necessary to put the cover in place to prevent electric shock causing personal injury.

### 3.Running

- It is prohibited to enable or disconnect motor unit during the running of inverter, so as to prevent overcurrent tripping even burning the main circuit.
- It is prohibited to remove the front cover of inverter during energizing to prevent electric shock causing personal injury.
- When the failure restart function is started, the motor will restart automatically after the running stops; please keep away from the machine at this time to avoid accident.
- Stop switch will not be enabled until being set, which is different from the emergency switch in use, please pay attention to it.

## 1.4 Storage

- Temperature of the storage environment shall range from -20℃ to +65℃ ;
- Relative humidity of the storage environment shall range from 0% to 95% in dry place without condensation or dust;
- There shall be no corrosive gas and liquid in the storage environment, it shall be put on shelter preferably with proper package;
- Long-term storage of inverter may cause deterioration of electrolytic capacitor, so it is necessary to switch it on over 5h once a year at least, and the voltage must rise to rated voltage value via a voltage regulator when inputting.



## No.2 Product Introduction

### 2.1 Specification of H100 series

| Model       | Input voltage             | Power (KW) | Capacity of driver (KVA) | Output current (A) | Applicable motor (KW) |
|-------------|---------------------------|------------|--------------------------|--------------------|-----------------------|
| H100-0.75S2 | Single-phase<br>220V 50Hz | 0.75       | 2.0                      | 5.0                | 0.75                  |
| H100-1.5S2  |                           | 1.5        | 2.8                      | 7.0                | 1.5                   |
| H100-2.2S2  |                           | 2.2        | 4.4                      | 11                 | 2.2                   |
| H100-3.7S2  |                           | 3.7        | 6.8                      | 17                 | 3.7                   |
| H100-0.75T4 | Three-phase<br>380V 50Hz  | 0.75       | 2.2                      | 2.7                | 0.75                  |
| H100-1.5T4  |                           | 1.5        | 3.2                      | 4.0                | 1.5                   |
| H100-2.2T4  |                           | 2.2        | 4.0                      | 5.0                | 2.2                   |
| H100-3.7T4  |                           | 3.7        | 6.8                      | 8.5                | 3.7                   |
| H100-5.5T4  |                           | 5.5        | 10                       | 12.5               | 5.5                   |
| H100-7.5T4  | 7.5                       | 14         | 17.5                     | 7.5                |                       |

### 2.2 General specification of the product

|   |  |              |
|---|--|--------------|
| Name                                    | H100 series  |              |
| Control mode                            | V/F , Vector control   |              |
| Input power                             | 380V power: 380±15%      220V power: 220±15%   |              |
| Four digital display & status indicator | Display frequency, current, rotating speed, voltage, counter, temperature, forward/reverse status, fault, etc. |              |
| Communication control                   | RS-485   |              |
| Operating temperature                   | -10~40℃  |              |
| Humidity                                | Relative humidity ranging from 0 to 95% (without condensation)   |              |
| Vibration                               | Below 0.5G   |              |
| Frequency                               | Range  | 0.1~1000.0Hz |

|                     |                                   |   |
|---------------------|-----------------------------------|---|
| control             | Accuracy                          | Digital type: 0.01% (-10~40°); analog type: 0.1% (25±10°)   |
|                     | Setting resolution                | Digital type: 0.01Hz; analog type: 1% of the maximum operating frequency  |
|                     | Output resolution                 | 0.01Hz  |
|                     | Keyboard setting mode             | Set as    directly |
|                     | Analog setting mode               | External voltage 0-5V, 0-10V, 4-20mA, 0-20mA.   |
|                     | Other functions                   | Three hopping frequencies (lower-frequency limit, startup frequency and stop frequency) can be set respectively   |
| General control     | Acceleration/deceleration control | 4 optional acceleration/deceleration time (0.1~6500 seconds)  |
|                     | Motor control mode                | V/F, vector control   |
|                     | Torque control                    | Torque can be set rising with the maximum of 10.0%, and it can reach 150% when starting at 1.0Hz  |
|                     | Multi-function input terminal     | 6-way programmable input; realize the functions like 8-segment speed control, program running, 4-segment acceleration/deceleration switching, UP, DOWN function, counter, external emergency stop, etc.   |
|                     | Multi-function output terminal    | 1-way programmable output; realize running, zero speed, counter, external exception, program running and other indications as well as alarm.  |
|                     | Other functions                   | Automatic voltage regulation (AVR), deceleration stop or free stop, DC brake, automatic reset and restart, frequency tracking, PLC program control, transverse control, draft control, automatic energy-saving running, carrier regulation (up to 20KHz), etc.        |
| Protection Function | Overload protection               | Electric relay protection motor driver (constant torque: 150% per minute, fans: 120% per minute).   |
|                     | FUSE protection                   | In case of fuse, the motor stops running  |
|                     | Over voltage                      | 220V: DC voltage>390V      380V: DC voltage>800V  |
|                     | Low voltage                       | 220V: DC voltage<200V      380V: DC voltage<400V  |

|  |                                  |  |
|--|----------------------------------|--|
|  | Restart after transient stop     | Restart after transient stop through frequency tracking mode   |
|  | Stall prevention                 | Stall prevention during acceleration/deceleration  |
|  | Short circuit of output terminal | Electronic circuit protection  |
|  | Other functions                  | Overheating protection of radiating fin, reverse limit, direct startup after operating, fault reset, parameter locking, etc. |



## No.3 Wiring

### 3.1 Arrangement of main circuit terminals

#### 1) Three-phases

|    |    |    |     |    |   |   |   |
|----|----|----|-----|----|---|---|---|
| L1 | L2 | L3 | DC+ | DB | U | V | W |
|----|----|----|-----|----|---|---|---|

#### 2) Single-phase

|   |   |  |     |    |   |   |   |
|---|---|--|-----|----|---|---|---|
| L | N |  | DC+ | DB | U | V | W |
|---|---|--|-----|----|---|---|---|

[Note] Screws on main control board serve as PE terminals for that of 0.4-1.5kW.

### 3.2 Arrangement of control terminals

|    |    |    |          |          |     |     |    |    |              |
|----|----|----|----------|----------|-----|-----|----|----|--------------|
| FC | FB | FA | 485<br>+ | 485<br>- | AO  | GND | X4 | X5 | X6/<br>Y1_FO |
|    |    |    | P12      | AI1      | AI2 | GND | X1 | X2 | X3           |

### 3.3 Description of main circuit terminals

| Symbol of terminal | Name of terminal         | Description   |
|--------------------|--------------------------|---|
| L1.L2.L3           | Input power terminal     | Connected to three-phases 380V power  |
| L.N                |                          | Connected to single-phase 220V power  |
| U.V.W              | Inverter output terminal | Connected to three-phase motor.   |
| DC+                | DC output + terminal     | DC bus output terminal is used for connecting external brake unit or common DC bus system. (DC- is not provided for partial models) |
| DC-                | DC output - terminal     |   |
| DB                 | Brake output terminal    | Connecting brake resistor between DB and DC+.   |
| PE                 | Earthing terminal        | Inverter housing earthing terminal must be earthed.   |

### 3.4 Description of control terminals

| Description | Description   | Description   |
|-------------|---|---|
| X1          | Multi-function digital input terminals 1-6                                      | Set as forward during delivery  |
| X2          |   | Set as reverse during delivery  |
| X3          |   | Set as reset during delivery  |
| X4          |   | Set as high speed during delivery   |
| X5          |   | Set as medium speed during delivery   |
| X6/Y1_FO    |   | Set as low speed during delivery  |
| GND         | Digital/analog/communication and power earthing terminals                       | Isolation of GND inside from PE   |
| P12         | +12V power supply   | Maximum output current: 150mA   |
| AI1         | Analog voltage input  | Input voltage range: 0~+10V   |
| AI2         | Analog current/voltage input, selecting via jumper J3, default to current input | Input current range: 0~+20mA<br>Input voltage range: 0~+10V                                     |
| AO          | Analog voltage output, can choose voltage or current                            | Output voltage range: 0~+10V<br>Input current range: 0/4~+20mA                                  |
| FA、FB、FC    | Multi-function relay output   | FA-FC: normally open,<br>FB-FC: normally close<br>Contact specification:<br>250VAC/3A, 30VDC/3A |
| 485+ , 485- | RS485 communication interface   | Available connection of 1-32 RS485 sites  |

### 3.5 Description of jumper function

| No. | Function  | Ex-factory setting |
|-----|---|--------------------|
| J1  | Selection of X1-X6 wiring mode: NPN PNP                 | PNP                |
| J2  | Selection of AO output: VO, voltage AO, current         | VO                 |
| J3  | Selection of AI2 input: V, voltage A, current           | A                  |
| J4  | RS485communication interface terminator enabled: ON OFF | OFF                |
| J5  | Selection of X6 terminal function reuse: X6 Y1_PFO      | X6                 |

Wiring mode of multi-function digital input terminals X1-X6:

(1) When NPN type wiring mode is adopted for external equipment, leakage type logic is induced and the current flows out from input terminal (sourcing current) as shown in Figure 3-1, at the same time parameter P067=0 is required.

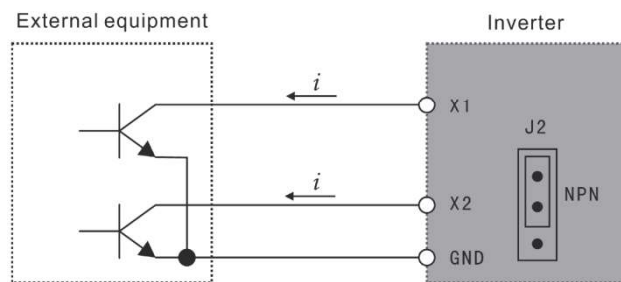

Figure 3-1 NPN Type Wiring Mode

(2) When PNP type wiring mode is adopted for external equipment, source-type logic is induced, and the current flows into from input terminal (sinking current) as shown in Figure 3-2, at the same time parameter P067=1 is required.

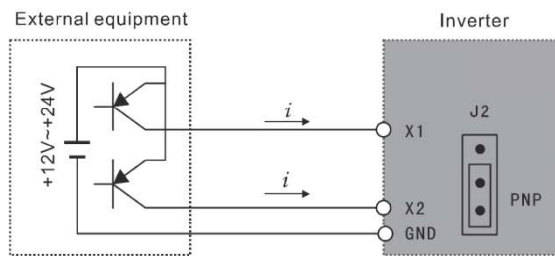

Figure 3-2 PNP Type Wiring Mode

### 3.6 Basic wiring diagram

Inverter wiring involves main circuit and control circuit. The user can raise the cover of housing, at this time main circuit terminal and control circuit terminal shall be viewed, and the user must conduct correct connection as per wiring circuit below.

Figure 3-3 below refers to standard wiring diagram of ex-factory H100 series.

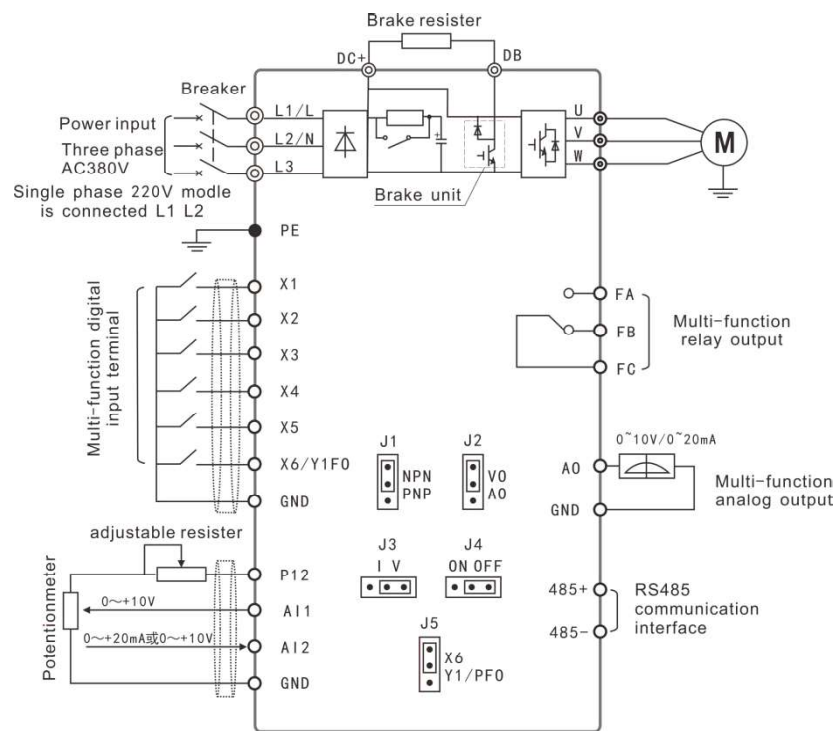

Figure 3-3 Standard Wiring of H100 series Inverter

---

## Main circuit wiring

- During wiring, please select wire diameter specification and conduct wiring as per those specified by electrical engineering laws so as to ensure the safety.
- For power supply wiring, prefer shielded wire or spool, and earth isolating layer or both ends of spool.
- Be sure to install air circuit breaker NFB between the power and input terminal (L1.L2.L3.L.N).  
(In case of applying leakage switch, please use the breaker with high frequency solution)
- Do not connect AC power to inverter output terminal (U.V.W).
- Prevent output wire touching metallic part of inverter housing; otherwise, earth short-circuit may be induced.
- Do not apply phase-shifting capacitor, LC, RC noise filter or other elements to output end of inverter.
- Indispensably make main circuit wiring of inverter away from other control equipment.
- When the wire between inverter and motor exceeds 15m (220V grade) or 30m (380V grade), extremely high dV/dT shall emerge inside motor coil and it shall produce damage to layer insulation of the motor, so it is necessary to use AC motor dedicated to inverter or install reactor onto inverter side.
- In case of long distance between inverter and motor, reduce carrier frequency, for the larger the carrier frequency is, the larger the higher harmonic leakage current becomes, which shall produce adverse effect on the inverter and other equipment.

### 1. Control circuit wiring

- It is not allowed to place signal wire and main circuit wire inside the same slot.
- Supply cord of signal wire should be shielded wire with the size of 0.5-2.0mm.
- Control terminal on control board should be correctly used as required.

### 2. Earth wire

- Please properly earth terminal PE of earth wire.  
220V grade: The third type earthing (earthing resistance is below 100)  
380V grade: Particularly the third type earthing (earthing resistance is below 10)
- Use earth wire as per fundamental length and size specified by electrical equipment technology.
- Absolutely avoid sharing earth electrode with welding machine, power generating machine and other large-scale power equipment and make earth wire away from power line of large-scale equipment as much as possible.
- Earth wire must be short to the utmost extent.



## No.4 Keyboard Description







### 4.1 Description of keyboard



Figure 4-1 H100 Series keyboard

Description of key function:

| Key graphics  | Key name | Function description  |
|---|----------|---|
|  | SET      | Enter into menu、 enter into parameter or parameter data writing confirm |
|  | ESC      | Return to the status of "ENTER"   |

|  |       |   |
|--|-------|---|
|   | UP    | parameters of function code, data etc increase/decrease, revise and select all kinds of modes |
|   | DOWN  |   |
|   | SHIFT | Status monitor mode switch, parameter of third stage menu switch                              |
|   | DIR   | Change the running direction of motor   |
|   | RUN   | Run command   |
|  | STOP  | Stop command/abnormal reset command   |

#### 4.2 Description of indicator functions

| Indicator          | Function description                            |
|--------------------|---|
| F/R                | off: reverse      on: reverse                   |
| RUN                | off: motor is stopped      on: motor is running |
| A                  | Unit of current: A                              |
| V                  | Unit of voltage: V                              |
| Hz                 | Unit of frequency: Hz                           |
| A + Hz combination | S, unit of time: S                              |
| V + Hz combination | %, %  |

---

### 4.3 Description of displayed items

| Displayed content | Description   |
|-------------------|---|
| r50.0             | Output frequency is 50.0Hz at this time                         |
| F50.0             | Set frequency is 50.0Hz   |
| A03.0             | Output current is 3.0A at this time                             |
| 1440              | Output speed is 1440r/min and speed light turns on at this time |
| U510              | DC voltage is 510V at this time                                 |
| U380              | AC voltage is 380V at this time                                 |
| t35.0             | Inverter temperature is 35.0l at this time                      |
| 0105              | Counter value is 105 at this time                               |
| n50.0             | PID target value is 50.0%                                       |
| n48.0             | PID feedback value is 48.0%                                     |



## No.5 Function List

Description of special symbols:

\* indicates that this parameter content has various set values or it shall be specifically set based on actual situation.

Ex-factory value refers to parameter value set during delivery of inverter or parameter value refreshed while the user restores ex-factory operation.

Alteration refers to alternative attribute of the parameter. □ indicates that the alteration is available during shutdown and operating, × indicates that the alteration is unavailable during operating, and Δ refers to read-only parameter which cannot be altered by the user.

### 5.1 Basic function parameters

| Function code | Name of function                   | Setting range and data content   | Ex-factory value | Alteration |
|---------------|------------------------------------|--|------------------|------------|
| F000          | Parameter locking                  | 0: Invalid 1: Valid  | 0                | □          |
| F001          | Control mode                       | 0: keyboard<br>1: External terminal<br>2: Communication port   | 0                | □          |
| F002          | Frequency setting selection        | 0: keyboard<br>1: AI1<br>2: Communication port<br>3: Operate potentiometer<br>4: AI2<br>5: PFI<br>6: AI1+AI2 | 3                | □          |
| F003          | Main frequency                     | 0.0~1000.0 Hz  | *                | □          |
| F004          | Reference frequency                | 0.1~1000.0 Hz  | 50.0             | □          |
| F005          | Maximum operating frequency        | 10.0~1000.0 Hz   | 50.0             | □          |
| F006          | Intermediate frequency             | 0.1~1000.0 Hz  | 5.0              | □          |
| F007          | Minimum frequency                  | 0.1~20.0 Hz  | 0.50             | □          |
| F008          | Maximum voltage                    | 0.1V~*   | 220/380          | □          |
| F009          | Intermediate voltage               | 0.1V~*   | *                | □          |
| F010          | Low-frequency torque boost voltage | 0.1V~50.0V   | *                | □          |

|      |   |  |     |   |
|------|---|--|-----|---|
| F011 | Lower frequency limit                               | 0.0~1000.0 Hz  | 0   | □ |
| F012 | Drive control mode                                  | 0: VF 1: vector control                                | 1   | □ |
| F013 | Parameter resetting                                 | 8 restore ex-factory value                             | 00  | □ |
| F014 | Acceleration time I                                 | 0.1~650.00s  | *   | □ |
| F015 | Deceleration time I                                 | 0.1~650.00s  | *   | □ |
| F016 | Acceleration time II                                | 0.1~650.00s  | *   | □ |
| F017 | Deceleration time II                                | 0.1~650.00s  | *   | □ |
| F018 | Acceleration time III                               | 0.1~650.00s  | *   | □ |
| F019 | Deceleration time III                               | 0.1~650.00s  | *   | □ |
| F020 | Acceleration time IV<br>(jogging acceleration time) | 0.1~650.00s  | *   | □ |
| F021 | Deceleration time IV<br>(jogging acceleration time) | 0.1~650.00s  | *   | □ |
| F022 | Emergency stop deceleration time                    | 0.1~650.00s<br>0.00 emergency stop by coasting to stop | 0.0 | □ |

## 5.2 Application function parameters

| Function code | Name of function         | Setting range and data content                                  | Ex-factory value | Alteration |
|---------------|--------------------------|---|------------------|------------|
| F023          | Reverse prohibit         | 0: Reverse prohibit<br>1: Reverse allow                         | 1                | □          |
| F024          | Stop key is valid or not | 0: STOP invalid 1: STOP valid                                   | 1                | □          |
| F025          | Start mode               | 0: Start from starting frequency<br>1: Frequency tracking start | 0                | □          |
| F026          | Reverse prohibit         | 0: Reverse prohibit<br>1: Reverse allow                         | 0                | □          |
| F027          | Starting frequency       | 0.1~30.0 Hz   | 0.5              | □          |
| F028          | Stop frequency           | 0.1~30.0 Hz   | 0.5              | □          |
| F029          | Start braking time       | 0.0~25.0s   | 0.0              | □          |
| F030          | Stop braking time        | 0.0~25.0s   | 0.0              | □          |
| F031          | DC braking level         | 0.0~20.0%   | 2.0              | □          |
| F032          | Frequency tracking time  | 0.1~20.0s   | 5.0              | □          |

|           |   |               |     |   |
|-----------|---|---------------|-----|---|
| F033      | Current tracking frequency level                      | 0~200%        | 150 | □ |
| F034      | Voltage rise time during frequency tracking           | 0.1~10.0s     | 0.5 | □ |
| F035      | Percentage of start voltage during frequency tracking | 1~20%         | 5   | □ |
| F036      | Voltage increment during frequency tracking           | 1~20V         | 10  | □ |
| F037-F038 |   | Reserve       |     |   |
| F039      | Starting frequency of DC BRAKING                      | 0~15          | 0   | □ |
| F040      | Frequency resolution                                  | 0.0~1000.0 Hz | *   | □ |
| F041      | Carrier frequency                                     | 0~15          | *   | □ |
| F042      | Jogging frequency                                     | 0.0~1000.0 Hz | 5.0 | □ |
| F043      | S curve time  | 0.0~6500.0s   | 0.0 | □ |

### 5.3 Functional parameters of input/output terminals

| Function code | Function name   | Setting range and data content  | Ex-factory value | Alteration |
|---------------|-----------------|---|------------------|------------|
| F044          | FOR(X1)function | 0: Invalid<br>1: Run<br>2: Forward<br>3: Reverse<br>4: Stop<br>5: Forward/reverse<br>6: Inching<br>7: Inching forward<br>8: Inching reverse<br>9: External control timer I<br>10: External control timer II<br>11: Setting frequency is forced to F003<br>12: Radiator or motor overheating | 02               | □          |
| F045          | REV(X2)function |   | 03               | □          |
| F046          | RST(X3)function |   | 14               | □          |
| F047          | SPH(X4)function |   | 22               | □          |
| F048          | SPM(X5)function |   | 23               | □          |
| F049          | SPL(X6)function |   | 24               | □          |

|      |   |   |    |   |
|------|---|---|----|---|
|      |   | 13: Emergency stop<br>14: Reset<br>15-16: Reserve<br>17: Acceleration/deceleration time selection I<br>18: Acceleration/deceleration time selection II<br>19: Multi-segment speed I<br>20: Multi-segment speed II<br>21: Multi-segment speed III<br>22: High speed<br>23: Medium speed<br>24: Low speed<br>25: PID allowed<br>26: Multi-segment speed IV<br>27: UP<br>28: DOWN<br>29: Draft allowed<br>30: Reserve<br>31: Pulse counter<br>32: Pulse counter resets   |    |   |
| F050 | Y1 output function                      | 0: Invalid<br>1: Indication during running<br>2: Zero-speed indication<br>3: Fault indication<br>4: DC braking indication<br>5: Setting frequency arrival indication<br>6: Accelerating indication<br>7: Decelerating indication<br>8: Frequency consistency arrival I indication<br>9: Frequency consistency arrival II indication<br>10: Motor overload indication<br>11: Over-torque indication<br>12: Inverter overload indication<br>13: Pulse setting counter arrival indication<br>14: Pulse middle counter arrival indication<br>15: External control timer I arrival indication<br>16: External control timer II arrival | 01 | □ |
| F051 | Y2 output function                      |   | 05 | □ |
| F052 | Output function (KA & KC are terminals) |   | 00 | □ |
| F053 | Output function (FA, FB & FC terminals) |   | 03 | □ |

|      |  |   |      |   |
|------|--|---|------|---|
|      |  | indication<br>17: Low-voltage indication<br>18: Internal control multi-segment speed stage completion indication<br>19: Internal control multi-segment speed<br>20: 4~20mA off line indication<br>21~23: reserve<br>24: ED0<br>25: auxiliary pump 1 motion indication<br>26: auxiliary pump 2 motion indication<br>27: draft finishing indication<br>28: PID lower limit alarm indication<br>29: PID up limit alarm indication<br>30: braking resistance motion indication<br>31: electromagnetism relay motion indication<br>32: fan motion indication |      |   |
| F054 | AO output function   | 0: output frequency<br>1: output current<br>2: DC bus voltage<br>3: output voltage  | 0    | □ |
| F055 | AO analog output gain  | 0~400%  | 100  | □ |
| F056 | Hopping frequency 1  | 0.0 ~ 1000.0Hz  | 0.00 | □ |
| F057 | Hopping frequency 2  | 0.0 ~ 1000.0Hz  | 0.00 | □ |
| F058 | Hopping frequency 3  | 0.0 ~ 1000.0Hz  | 0.00 | □ |
| F059 | Range of hopping frequency   | 0.1 ~ 10.0 Hz   | 0.50 | □ |
| F060 | Frequency consistency I<br>(constant pressure water supply high speed frequency) | 0.0~1000.0 Hz   | 0.00 | □ |
| F061 | Frequency consistency II<br>(constant pressure water supply low                  | 0.0~1000.0 Hz   | 0.00 | □ |

|      | speed frequency)                                  |  |      |   |
|------|---|--|------|---|
| F062 | Frequency Consistency range setting               | 0.1~10.0 Hz  | 0.50 | □ |
| F063 | Timer I   | 0.1 ~ 10.0s  | 0.1  | □ |
| F064 | Timer II  | 1~ 100s  | 1    | □ |
| F065 | Count value                                       | 0~65500  | 0    | □ |
| F066 | Value of middle counter                           | 0~65500  | 0    | □ |
| F067 | Digital input terminal Positive & negative logic  | 0: Positive logic, wiring mode NPN<br>1: Negative logic, wiring mode PNP | 01   | □ |
| F068 | Digital input terminal dithering elimination time | 0~60000ms  | 20   | □ |
| F069 | PFO maximum frequency                             | 1.0~10.0   | 10.0 | □ |

#### 5.4 Functional parameters of analog quantity

| Function code | Function name                                       | Setting range and data content  | Ex-factory value | Alteration |
|---------------|---|---|------------------|------------|
| F070          | Input channel selection for analog quantity         | unit's digit:<br>0: 0~10V 1: 0~5V<br>Ten's digit:<br>0: 0~20mA/0~10V<br>1: 4~20mA/2~10V | 00               | □          |
| F071          | Filtering time of analog quantity                   | 0~1000ms  | 20               | □          |
| F072          | High-end frequency of analog frequency              | 0.0~1000.0 Hz   | 50.00            | □          |
| F073          | Low-end frequency of analog quantity                | 0.0~1000.0 Hz   | 0                | □          |
| F074          | Bias direction of high-end frequency                | 0: Positive<br>1: Negative  | 0                | □          |
| F075          | Bias direction of low-end frequency                 | 0: Positive<br>1: Negative  | 0                | □          |
| F076          | Selectable negative bias reverse of analog quantity | 0: Irreversible<br>1: Reversible  | 0                | □          |
| F077          | UP.DOWN memory function selection                   | 0: Not memorized<br>1: Memorized  | 0                | □          |
| F078          | UP.DOWN increment selection                         | 0: 0.1Hz 1: 1.0Hz   | 1                | □          |
| F079          | UP.DOWN increment multiple                          | 1~250   | 1                | □          |

## 5.5 Functional parameters of multi-segment speed

| Function code | Function description   | Setting range and data content  | Ex-factory value | Alteration |
|---------------|--|---|------------------|------------|
| F080          | Selection of multi-segment speed mode  | 0:Normal operation<br>1:Internally controlled 16-segment speed<br>2:Externally controlled 4-segment speed<br>3:Externally controlled 16-segment speed<br>4:Externally controlled 4-segment speed(command valid automatically)<br>5: Externally controlled 6-segment speed(command | 2                | □          |
| F081          | Internally controlled multi-segment speed Selection of operation mode        | 0: Stop after operating for one cycle<br>1: Circulating operation<br>2: Stop after automatically operating for one cycle (STOP interval)  | 0                | □          |
| F082          | Speed operation directions of first internally controlled 8 segments         | 0~255 (0: forward 1: reverse)   | 0                | □          |
| F083          | Speed operation directions of last internally controlled 8 segments          | 0~255 (0: forward 1: reverse)   | 0                | □          |
| F084          | Acceleration/deceleration time of the first internally controlled 8 segments | 0~65535   | 0                | □          |
| F085          | Acceleration/deceleration time of the last internally controlled 8 segments  | 0~65535   | 0                | □          |



|      |   |               |       |   |
|------|---|---------------|-------|---|
| F086 |   | 0.0~1000.0 Hz | 15.00 |   |
| F087 | Frequency II setting                                    | 0.0~1000.0 Hz | 20.00 |   |
| F088 | Frequency III setting                                   | 0.0~1000.0 Hz | 25.00 |   |
| F089 | Frequency IV setting                                    | 0.0~1000.0 Hz | 30.00 |   |
| F090 | Frequency V setting                                     | 0.0~1000.0 Hz | 35.00 |   |
| F091 | Frequency VI setting                                    | 0.0~1000.0 Hz | 40.00 |   |
| F092 | Frequency VII setting                                   | 0.0~1000.0 Hz | 0.50  |   |
| F093 | Frequency IX setting                                    | 0.0~1000.0 Hz | 10.00 | □ |
| F094 | Frequency X setting                                     | 0.0~1000.0 Hz | 15.00 |   |
| F095 | Frequency XI setting                                    | 0.0~1000.0 Hz | 20.00 |   |
| F096 | Frequency XII setting                                   | 0.0~1000.0 Hz | 25.00 |   |
| F097 | Frequency XIII setting                                  | 0.0~1000.0 Hz | 30.00 |   |
| F098 | Frequency XIV setting                                   | 0.0~1000.0 Hz | 35.00 |   |
| F099 | Frequency XV setting                                    | 0.0~1000.0 Hz | 40.00 |   |
| F100 | Frequency XVI setting                                   | 0.0~1000.0 Hz | 45.00 |   |
|      | Internally controlled<br>multi-segment speed timer I    |               |       |   |
| F101 | Internally controlled<br>multi-segment speed timer II   | 0.0~6500.0s   | 10.0  |   |
| F102 | Internally controlled<br>multi-segment speed timer III  | 0.0~6500.0s   | 10.0  |   |
| F103 | Internally controlled<br>multi-segment speed timer III  | 0.0~6500.0s   | 0.0   |   |
| F104 | Internally controlled<br>multi-segment speed timer IV   | 0.0~6500.0s   | 0.0   |   |
| F105 | Internally controlled<br>multi-segment speed timer IV   | 0.0~6500.0s   | 0.0   |   |
| F106 | Internally controlled<br>multi-segment speed timer V    | 0.0~6500.0s   | 0.0   |   |
| F107 | Internally controlled<br>multi-segment speed timer V    | 0.0~6500.0s   | 0.0   |   |
| F108 | Internally controlled<br>multi-segment speed timer VI   | 0.0~6500.0s   | 0.0   |   |
| F109 | Internally controlled<br>multi-segment speed timer VI   | 0.0~6500.0s   | 0.0   | □ |
| F110 | Internally controlled<br>multi-segment speed timer VII  | 0.0~6500.0s   | 0.0   |   |
| F111 | Internally controlled<br>multi-segment speed timer VII  | 0.0~6500.0s   | 0.0   |   |
| F112 | Internally controlled<br>multi-segment speed timer VIII | 0.0~6500.0s   | 0.0   |   |
| F113 | Internally controlled<br>multi-segment speed timer VIII | 0.0~6500.0s   | 0.0   |   |
| F114 | Internally controlled<br>multi-segment speed timer IX   | 0.0~6500.0s   | 0.0   |   |
| F115 | Internally controlled<br>multi-segment speed timer IX   | 0.0~6500.0s   | 0.0   |   |
| F116 | Internally controlled<br>multi-segment speed timer X    | 0.0~6500.0s   | 0.0   |   |
|      | Internally controlled<br>multi-segment speed timer X    |               |       |   |
|      | Internally controlled<br>multi-segment speed timer XI   |               |       |   |
|      | Internally controlled<br>multi-segment speed timer XI   |               |       |   |

|      |  |     |   |   |
|------|--|-----|---|---|
|      | multi-segment speed timer<br>XII<br>Internally controlled<br>multi-segment speed timer<br>XIII<br>Internally controlled<br>multi-segment speed timer<br>XIV<br>Internally controlled<br>multi-segment speed timer<br>XV<br>Internally controlled<br>multi-segment speed timer<br>XVI |     |   |   |
| F117 | Internally controlled<br>multi-segment speed<br>memory function(UP.DOWN<br>power fault reserve)  | 0~1 | 0 | □ |

## 5.6 Protection function parameters

| Function code | Function   | Setting range & function description  | Ex-factory value | Alteration |
|---------------|--|---|------------------|------------|
| F118          | Selection of over-voltage stall                  | 0~1   | 1                | □          |
| F119          | Stalling level during accelerating               | 0~200%  | 150              | □          |
| F120          | Stalling level during constant speed             | 0~200%  | 150              | □          |
| F121          | Stalling deceleration time during constant speed | 0.1~25.5s   | 5                | □          |
| F122          | Prevent of over-voltage stalling level           | 200~800V  | Motor type       | □          |
| F123          | Selection of over-torque detection mode          | 0~3   | 0                | □          |
| F124          | Selection of over-torque detection mode          | 0~200%  | 0                | □          |
| F125          | Over-torque detection level                      | 0.1~20.0s   | 1.0              | □          |
| F126          | Over-torque detection time                       | 0~1   | 0                | □          |
| F127          | Pulse counter memory                             | 0~65000   | 0                | □          |
| F128          | Cooling fan control                              | 0: running always<br>1: control by running command, delayed 30S after turning off | 0                | □          |
| F129          | Dynamic braking voltage                          | 0~800V  | Motor type       | □          |

## 5.7 Function parameters of constant-pressure water supply

| Function node | Function description              | Setting range & function description | Ex-factory value | Alteration |
|---------------|-----------------------------------|--------------------------------------|------------------|------------|
| F130          | Quantity of auxiliary             | 0~2                                  | 0                | □          |
| F131          | Continuous time of auxiliary pump | 1~9000min                            | 60               | □          |

|      |                                     |              |       |   |
|------|-------------------------------------|--------------|-------|---|
| F132 | Interlocking time of auxiliary pump | 1~250s       | 5     | □ |
| F133 | High-speed operating time           | 1~250s       | 60    | □ |
| F134 | Low-speed operating time            | 1~250s       | 60    | □ |
| F135 | Stop pressure level                 | 1~150%       | 95    | □ |
| F136 | Stop level continuous time          | 1~250s       | 30    | □ |
| F137 | Wake-up level                       | 1~150%       | 80    | □ |
| F138 | Sleep frequency                     | 0.0~1000.0Hz | 20.00 | □ |
| F139 | Continuous time of sleep frequency  | 1~250s       | 20    | □ |

## 5.8 Motor function parameters

| Function code | Function description                      | Setting range & function description | Ex-factory value | Alteration |
|---------------|---|--------------------------------------|------------------|------------|
| F140          | Rated power of motor                      | Set as per motor nameplate           | *                | □          |
| F141          | Rated voltage of motor                    | Set as per motor nameplate           | *                | □          |
| F142          | Rated current of motor                    | Set as per motor nameplate           | *                | □          |
| F143          | Number of motor poles                     | 02~22                                | 04               | □          |
| F144          | Rated rotating speed of motor             | 00~9999                              | 1440             | □          |
| F145          | Automatic torque compensation             | 0.0~10.0%                            | 2.0              | □          |
| F146          | Motor no-load current                     | 0~100%                               | 40               | □          |
| F147          | Motor slip compensation                   | 0~1.0                                | 0.000            | □          |
| F148          | Motor slip compensation maximum frequency | 0.0~20.0Hz                           | 2.0              | □          |
| F149          | Motorslip compensation filtering time     | 0~200ms                              | 10               | □          |
| F150          | AVR function                              | 0 ~ 1                                | 1                | □          |
| F151          | Automatic energy-saving function          | 0.0~20.0%                            | 0.0              | □          |

|      |                                     |                                  |     |   |
|------|-------------------------------------|----------------------------------|-----|---|
| F152 | Fault restart time                  | 0.2~25.0s                        | 1.0 | □ |
| F153 | Selection of transient stop restart | 0: Invalid 1: Frequency tracking | 0   | □ |
| F154 | Allowed power fault time            | 0.1~5.0s                         | 0.5 |   |
| F155 | Times of fault restart              | 0 ~ 10                           | 00  |   |

### 5.9 PID function parameters

| Function code | Function name           | Setting range & content description  | Ex-factor y value | Alteration |
|---------------|-------------------------|--|-------------------|------------|
| F156          | Proportional constant P | 0.0~1000.0%  | 100.0             | □          |
| F157          | Integration time I      | 0.1~3600.0s 0 close integration  | 2.0               | □          |
| F158          | Derivation time D       | 0.01~10.00s, 0 close derivation  | 0                 | □          |
| F159          | target value            | 0.0~100.0%   | 0                 | □          |
| F160          | PID channel setting     | Unit's digit: PID setting channel<br>0;set by F159<br>1: AI1<br>2: AI2<br>Ten's digit: PIDfeedback channel<br>0:AI1 1: AI2 | 10                | □          |
| F161          | PID up limit            | 0~100%   | 100               | □          |
| F162          | PID lower limit         | 0~100%   | 0                 | □          |

### 5.10 Communication function parameters

| Function code | Function name                    | Setting range and content description | Ex-factor y value | Alteration |
|---------------|----------------------------------|---------------------------------------|-------------------|------------|
| F163          | Communication address            | 0~250                                 | 1                 | □          |
| F164          | Communication transmission speed | 0~3                                   | 2                 |            |
| F165          | Communication data mode          | 0~5                                   | 3                 |            |
| F166~F168     |                                  | reserve                               |                   |            |

|      |                                     |                              |   |   |
|------|-------------------------------------|------------------------------|---|---|
| F169 | Selection of communication protocol | 0: Standard Modbus Agreement | 0 | □ |
|------|-------------------------------------|------------------------------|---|---|

### 5.11 Monitoring function parameters

| Function code | Function                              | Setting range and content description  | Ex-factory value | Alteration |
|---------------|---------------------------------------|--|------------------|------------|
| F170          | Selection of extension display 1      | 0~11<br>0: not displayed   | 4                | □          |
| F171          | Selection of extension display 2      | 1: PID feedback value<br>2: operation speed<br>3: PID target value<br>4: bus voltage<br>5: heat sink temperature<br>6: counter<br>7: output torque<br>8: input terminal status<br>9: AI1 10: AI2 11: PFI | 5                |            |
| F172          | Fault clearing                        |  | *                | □          |
| F173          | Rated voltage of inverter             | 00-10 (01 refers to fault clearing)  | *                |            |
| F174          | Rated current of inverter             | Set as per machine model   | *                |            |
| F175          | Type of inverter                      | Set as per machine model   | 0                |            |
| F176          | Frequency standard of inverter        | 0: Constant torque 1: Fan model<br>0: 50Hz 1: 60Hz   | 0                |            |
| F177          | Unexpected error 1                    |  | —                | □          |
| F178          | Unexpected error 2                    | Note:  | —                |            |
| F179          | Unexpected error 3                    | —means no fault record   | —                |            |
| F180          | Unexpected error 4                    |  | —                |            |
| F181          | Software version No.                  | 00~02  | 00               | □          |
| F182          | Running time                          | 0~3600s  |                  | □          |
| F183          | Cumulative running time               | 0~65535h   |                  | □          |
| F184          | RPM display factor                    | 0.000~9.999  | 1.000            | □          |
| F185          | Selection of starting pre-set display | 0~5<br>0: output frequency   | 0                | □          |

---

|           |  |  |  |  |
|-----------|--|--|--|--|
|           |  | 1: setting frequency<br>2: output current<br>3: output voltage<br>4: setting by F170<br>5: setting by F171 |  |  |
| F186~F250 |  | reserve  |  |  |

## No.6 Detailed Function Descriptions

### 6.1 Basic function parameters

| F000              | Setting range | Unit | Ex-factory value | Change |
|-------------------|---------------|------|------------------|--------|
| Parameter locking | 0-1           | 1    | 0                | □      |

0: Invalid

1: Valid (parameter locking, meaning other parameters are unchangeable except this parameter.)

This parameter can avoid mistake operation of non-operators which may cause unnecessary danger and mistake. But after locking parameters, the current frequency can be changed through keys  $\square$  and  $\square$ .

| F001                      | Setting range | Unit | Ex-factory value | Alteration |
|---------------------------|---------------|------|------------------|------------|
| Selection of control mode | 0-2           | 1    | 0                | □          |

0: Keyboard setting (Operating command is set by keyboard.)

1: External terminals setting (Operating command is set by 6-way programmable input terminals.)

2: Communication interface setting (Operating command is set by transmission of communication interface)

| F002                        | Setting range | Unit | Ex-factory value | Alteration |
|-----------------------------|---------------|------|------------------|------------|
| Frequency setting selection | 0-3           | 1    | 0                | □          |

0: Keyboard setting (F003 of former operating frequency is set by keyboard.)

1: Analog quantity setting (Former operating frequency is controlled by input analog signals and signal type is decided by F070. Refer to F070-F076 for relevant parameters.)

2: Communication interface setting (Current operating frequency is set by serial port communication.)

3: Potentiometer of keyboard (Current operating frequency is set by potentiometer knob on keyboard.)

5: Inpulse input setting

6: Analog quantity AI1+AI2 setting

| F003           | Setting range | Unit    | Ex-factor | Alteration |
|----------------|---------------|---------|-----------|------------|
| Main frequency | 0.0~1000.0 Hz | 0.01 Hz | *         | □          |

In case that frequency option is set by keyboard, the frequency operates with set value of



F003. During operating, the current operating frequency can be changed with keys  $\square$  and  $\square$ . In multi-segment operation, main frequency is taken as frequency I. If F002 is set as 1, i.e. the external analog quantity is set, the frequency I is set by analog quantity of external terminals. Main frequency setting is limited by maximum operating frequency.

Relevant parameters: F002 and F080. These parameters are adjustable during operating.

| F004                | Setting range | Unit    | Ex-factory | Alteratio |
|---------------------|---------------|---------|------------|-----------|
| Reference frequency | 0.1~1000.0Hz  | 0.01 Hz | 50.00      | $\square$ |

This setting must be conducted as per the motor's rated running voltage frequency on motor nameplate. Generally, the frequency setting value shall not be changed at will. In case of being equipped with special motor, please set properly as per the motor parameter characteristics, otherwise, the equipment will be damaged.

| F005                        | Setting range  | Unit    | Ex-factory | Alteration |
|-----------------------------|----------------|---------|------------|------------|
| Maximum operating frequency | 10.0~1000.0 Hz | 0.01 Hz | 50.00      | $\square$  |

This parameter decides the maximum operating frequency of the inverter.

| F006                   | Setting range | Unit    | Ex-facto | Alteratio |
|------------------------|---------------|---------|----------|-----------|
| Intermediate frequency | 0.1~1000.0 Hz | 0.01 Hz | 5.0      | $\square$ |

This parameter can set the intermediate frequency value in any V/F curve. Improper setting will cause insufficient start up torque of inverter or motor over current and even tripping of inverter. The setting value of intermediate frequency is limited by that of reference frequency.

| F007              | Setting range | Unit   | Ex-factor | Alteration |
|-------------------|---------------|--------|-----------|------------|
| Minimum frequency | 0.1~200.0 Hz  | 0.1 Hz | 0.5       | $\square$  |

This parameter decides the minimum startup frequency value in V/F curve.

| F008            | Setting range | Unit | Ex-factory | Alteration |
|-----------------|---------------|------|------------|------------|
| Maximum voltage | 0.1-*         | 0.1V | 220/380    | $\square$  |

This value shall be set as per rated value on motor's nameplate. The ex-factory value of 380V grade is 380V while that of 220V grade is 220V. This parameter setting range is limited by voltage grade of inverter. And at the sites where motor is relatively far away from inverter, this value can be appropriately increased.

| F009                 | Setting range | Unit | Ex-factor | Alteration |
|----------------------|---------------|------|-----------|------------|
| Intermediate voltage | 0.1~510.0V    | 0.1V | *         | $\square$  |

This parameter can set intermediate voltage values in any V/F curve. Improper setting may

cause motor over current or insufficient torque and even inverter tripping. Augmenting intermediate voltage may augment the output torque and the output current will increase at the same time. When modifying this parameter, please monitor the output current so as to avoid over current and tripping of inverter.

Intermediate voltage setting value is limited by maximum voltage setting value. When intermediate voltage increases to a certain value, the torque compensation may lose its utility. When adjusting this parameter, slowly increase the output current of inverter from small to large as per the mechanical load until it meets the startup requirements and do not improve the current with large amplitude, otherwise inverter tripping or equipment damage may occur.

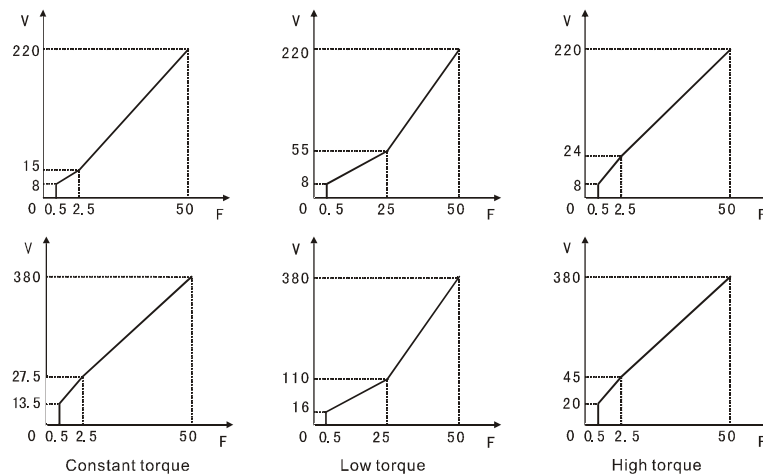

Figure 6-1 Common Curves and Setting Values

| F010                                    | Setting value | Unit | Ex-factor | Alteration |
|---|---------------|------|-----------|------------|
| Booster voltage of low-frequency torque | 0.1~380.0V    | 0.1V | *         | □          |

This parameter sets the lowest startup voltage value in V/F curve. F010 setting value is limited by voltage of maximum operating frequency. This parameter can compensate the insufficient torque at low frequency, but the torque compensation shall not be too large and shall be set from small to large slowly according to actual situations. Insufficient compensation may cause insufficient torque when motor is at low frequency, while excessive compensation may cause excessive torque and generate impact to machinery and even may cause inverter tripping if severe. V/F curves are determined by F006-F010. This manual supplies several common V/F curves for reference, such as Figure 6-1. Specific

curves shall be set as per mechanical load characteristics.

| F011                     | Setting range | Unit    | Ex-factory | Alteration |
|--------------------------|---------------|---------|------------|------------|
| Lower limit of frequency | 0.0~1000.0    | 0.01 Hz | 0.00       | □          |

The purpose of lower limit of frequency is to prevent misoperation of site personnel and avoid overheat or other mechanical fault due to too low running frequency of motor. The setting of lower limit of frequency must be smaller than the setting value of upper limit of frequency.

| F012               |       |                   |  |  |
|--------------------|-------|-------------------|--|--|
| Drive control mode | 0: VF | 1: vector control |  |  |

| F013            | Setting range | Unit | Ex-factor | Alteration |
|-----------------|---------------|------|-----------|------------|
| Parameter reset | 00~10         | 1    | 00        | □          |

If the setting of parameter values is improper or abnormal, set them as 08 and reset it after the ex-factory value is recovered. After being locked (when F000=1), the parameters can not be reset unless they are unlocked. Relevant parameter: F000.

| F014  | Setting range | Unit | Ex-factory value | Alteration |
|---|---------------|------|------------------|------------|
| Acceleration time I                                 | 0.1~6500.0s   | 0.1s | *                | □          |
| F015  |               |      |                  |            |
| Deceleration time I                                 |               |      |                  |            |
| F016  |               |      |                  |            |
| Acceleration time II                                |               |      |                  |            |
| F017  |               |      |                  |            |
| Deceleration time II                                |               |      |                  |            |
| F018  |               |      |                  |            |
| Acceleration time III                               |               |      |                  |            |
| F019  |               |      |                  |            |
| Deceleration time III                               |               |      |                  |            |
| F020  |               |      |                  |            |
| Acceleration time IV<br>(Jogging acceleration time) |               |      |                  |            |

|   |  |  |  |  |
|---|--|--|--|--|
| F021  |  |  |  |  |
| Deceleration time IV<br>(Jogging deceleration time) |  |  |  |  |

Acceleration time refers to the time required by the inverter to accelerate from 0Hz to maximum operating frequency. Refer to t1 in Figure 6-2 for details; deceleration time refers to the time required by the inverter to decelerate from maximum operating frequency to 0Hz. Refer to t2 in Figure 6-2 for details.

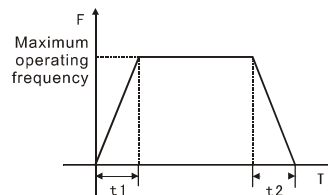

Figure 6-2 Acceleration/deceleration Time Curves

H100 series of inverters define four kinds of acceleration/deceleration time in all from acceleration/deceleration I to IV. Users can select different acceleration/deceleration time through the corresponding function switching of acceleration/deceleration time at external switch terminals as required; and select different acceleration/deceleration time through relevant parameters of internally controlled multi-segment speed during internally controlled multi-segment speed operation.

Generally, the inverter defaults acceleration/deceleration time I. The ex-factory value of acceleration/deceleration time I is set as per model and acceleration/deceleration time IV refers to jog acceleration/deceleration time.

Relevant parameters: F044-F049, F084, F085 .

| F022                             | Setting range  | Unit | Ex-factory value | Alteration |
|----------------------------------|--|------|------------------|------------|
| Emergency stop deceleration time | 0.1~6500.0s<br>0.0 refer to emergency stop set by coasting to stop | 0.1s | 0.0              | □          |

Inverter deceleration stop is set by emergency stop deceleration time during emergency stop, if emergency stop deceleration time is 0.0, it means emergency stop is set by coasting to stop. Emergency stop command can be get from digital input terminal 13 function(emergency stop).

## 6.2 Application function parameters

| F023             | Setting range | Unit | Ex-factory value | Alteration |
|------------------|---------------|------|------------------|------------|
| Reverse prohibit | 0~1           | 1    | 1                | □          |

0: Reverse prohibit      1: Reverse valid

This parameter setting is applied to sites where motor is irreversible so as to avoid misoperation of operators. When reverse is prohibited, motor can only rotate in a forward way rather than in a reverse way.

| F024                     | Setting range | Unit | Ex-factory value | Alteration |
|--------------------------|---------------|------|------------------|------------|
| Stop key is valid or not | 0~1           | 1    | 1                | □          |

0: STOP key is invalid      1: STOP key is valid

When control mode refers to external terminal control or communication control, the stop key on the panel can select whether to be valid. If selecting valid, the panel will stop the inverter. If it is necessary to restart, remove the running signal firstly and then restart the inverter

This parameter is only valid when F001 is set as 1 or 2.

| F025          | Setting range | Unit | Ex-factory value | Alteration |
|---------------|---------------|------|------------------|------------|
| Start up mode | 0~1           | 1    | 0                | □          |

Two kinds of start up modes can be set as required by different equipment.

0: Start from start up frequency. When F029 is set as zero, the DC braking at the time of start up is invalid and the start up shall be conducted from start-up frequency. When F029 is not zero, the DC braking at the time of start up is valid; when starting, firstly start the DC braking and then start from start-up frequency ( F027 ) .

1: Frequency tracking startup: this parameter can be used to restart of high-inertia load. When restarting, the frequency set by inverter will make frequency tracking downward. When restarting, operating command can be executed without fully stopping of equipment and tracking startup also can be made to save time if there is high-inertia load equipment.

Refer to figure 6-3 as detailed.

Refer to P027,P029 and 031P for relevant parameters.

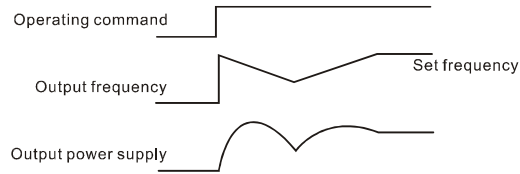

Figure 6-3 Frequency Tracking Startup

[Note] During frequency tracking startup, the frequency set by inverter will make frequency tracking downward and carry out tracking at the maximum speed. During starting, the current may be relatively large and overcurrent or stalling phenomenon may occur. It is necessary to pay attention to the adjustment of tracking current level. F033 is generally set at about 100 and shall be specifically set as per the mechanical inertia.

| F026      | Setting range | Unit | Ex-factory value | Alteration |
|-----------|---------------|------|------------------|------------|
| Stop mode | 0~1           | 1    | 0                | □          |

0: For deceleration stop, when F030 is 0, DC braking is invalid. When DC braking is invalid, the inverter will decelerate to stop frequency and stop output, and motor will stop in self-running manner. When F030 is not 0, DC braking is valid, after inverter decelerates to stop frequency, it will stop in DC braking manner. When stopping, DC braking is usually used for high-position stop or positioning control. Note: frequently using DC braking may cause overheat of motor. Relevant parameters are F028, F030 and F031.

1: After free running stop inverter receives stop command, inverter will immediately stop output and motor will stop in free running manner. Under such manner, DC braking is invalid.

| F027              | Setting range | Unit  | Ex-factory value | Alteration |
|-------------------|---------------|-------|------------------|------------|
| Startup frequency | 0.1~30.0 Hz   | 0.1Hz | 0.5              | □          |

Startup frequency refers to initial starting frequency of inverter, for instance, when the startup frequency is set as 5.0 Hz, inverter will run between 5.0Hz to maximum operation frequency after it is started at 5.0Hz.

Relevant parameters: F025, F029 and F031.

| F028           | Setting range | Unit  | Ex-factory value | Alteration |
|----------------|---------------|-------|------------------|------------|
| Stop frequency | 0.1~30.0 Hz   | 0.1Hz | 0.5              | □          |

When inverter is under deceleration stop and frequency decreases to stop frequency, the inverter will stop output or start DC braking stop.

When F030 is 0, the DC braking when stopping is invalid and inverter will stop output when it decreases to F028. When F030 is set as valid, inverter will stop in DC braking manner when it decreases to F028.

Relevant parameters: F028, F030 and F031.

| F029                 | Setting range | Unit | Ex-factory value | Alteration |
|----------------------|---------------|------|------------------|------------|
| DC braking time when | 0.0~25.0s     | 0.1s | 0.0              | □          |

This parameter will enter DC braking status when it is set as startup and will be input into duration time of motor DC braking current. When it is set as zero, it means the DC braking is invalid. Refer to Figure 6-4 for details.

DC braking start up is usually used when load can move under fan stop status for motor will be in free running status with uncertain direction before inverter outputs voltage. Therefore, we can execute DC braking before startup and then start the motor to avoid the tripping of motor.

Parameters will be valid when F025 is set as zero. Refer to F028, F029 and F031 for relevant parameters.

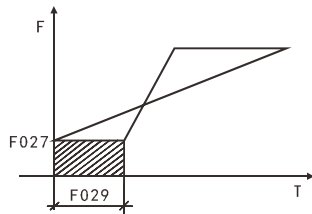

Figure 6-4 DC Braking Time when Starting

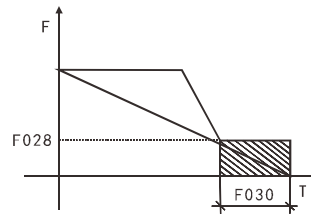

Figure 6-5 DC Braking Time when Stopping

| F030                          | Setting range | Unit | Ex-factory value | Alteration |
|-------------------------------|---------------|------|------------------|------------|
| DC braking time when stopping | 0.0~25.0s     | 0.1s | 0.0              | □          |

When this parameter is set as non-zero, the DC braking when stopping is valid and it will enter the motor DC braking time. When stopping, DC braking is usually used for high-position stop or positioning control. When this parameter is zero, DC braking is invalid. Refer to Figure 6-5 for details.

This parameter is valid when F026 is set as zero. Refer to F026, F028 and F031 for related descriptions.

| F031             | Setting range | Unit | Ex-factory value | Alteration |
|------------------|---------------|------|------------------|------------|
| DC braking level | 0.0~20.0%     | 0.1% | 2.0              | □          |

This parameter can be used to set the input motor DC braking voltage when starting and stopping and adjusted to obtain different braking voltages. The parameter must be adjusted from small to large slowly until sufficient braking torque is reached, otherwise the motor will be damaged.

100% voltage shall be used for maximum operation frequency.

| F032                    | Setting range | Unit | Ex-factory value | Alteration |
|-------------------------|---------------|------|------------------|------------|
| Frequency tracking time | 0.1~20.0s     | 0.1s | 5.0              | □          |

In case of external exception or temporary power failure, this parameter will be set as frequency tracking time when inverter is executing frequency tracking. In some large inertia load starting and stopping, restarting after machinery fully stops will waste much time for load inertia is large. After frequency tracking is enabled, the starting can be executed without complete stop of machinery. And inverter will conduct frequency tracking from top to down with set frequency and then continue to accelerate to set frequency after tracking.

| F033                             | Setting | Unit | Ex-factory value | Alteration |
|----------------------------------|---------|------|------------------|------------|
| Frequency tracking current level | 0~200%  | 1%   | 150              | □          |

When inverter is executing frequency tracking, output current shall take this set value as level. When output current is larger than this level, the frequency will drop and make current below current level, and then re-execute the frequency tracking.

| F034  | Setting range | Unit | Ex-factory value | Alteration |
|---|---------------|------|------------------|------------|
| Voltage rising time during frequency tracking | 0.1~10.0s     | 0.1s | 0.5              | □          |

When startup mode of inverter is set as frequency tracking, there is a voltage rising process. When the voltage rising is too fast, the current will be very large and the tracking process will be fast. If the voltage rising is slow, the current will be small and tracking will also be slow. The general setting mode is that for machinery with small power, F034 shall be set as a small value while for machinery with large power.



|            |         |
|------------|---------|
| F035- F040 | reserve |
|------------|---------|

| F041              | Setting range | Unit | Ex-factory value | Alteration |
|-------------------|---------------|------|------------------|------------|
| Carrier frequency | 0~15          | 1    | *                | ∥          |

Carrier frequency is related to electromagnetic noise of motor as well as to inverter's heat productivity and disturbance to environment. Refer to the following table:

| Carrier frequency | Electromagnetic noise | Heat productivity | Disturbance to environment |
|-------------------|-----------------------|-------------------|----------------------------|
| Small<br>↓        | Large<br>↓            | Small<br>↓        | Small<br>↓                 |
| Large             | Small                 | Large             | Large                      |

Carrier Mapping Table:

| Setting value         | 0    | 1 | 2 | 3 | 4 | 5 | 6 | 7 | 8 | 9  | 10 | 11 | 12 | 13 | 14 | 15 |
|-----------------------|------|---|---|---|---|---|---|---|---|----|----|----|----|----|----|----|
| Carrier frequency KHz | 1.25 | 2 | 3 | 4 | 5 | 6 | 7 | 8 | 9 | 10 | 11 | 12 | 13 | 14 | 15 | 16 |

The higher the carrier frequency is, the smaller the motor's electromagnetic noise will be, but the disturbance to other systems will be stronger and the heat productivity of inverter will be larger. When the ambient temperature is relatively high and the motor load is relatively heavy, we can appropriately reduce the carrier frequency to improve the heat characteristics of inverter. The ex-factory value of carrier frequency is set as per model.

| F042          | Setting range | Unit  | Ex-factory value | Alteratio |
|---------------|---------------|-------|------------------|-----------|
| Jog frequency | 0.0~1000.0Hz  | 0.1Hz | 5.00             | ∥         |

This parameter can realize the jog function in machine testing and jog operation only can be realized through 6-way programmable terminals. Jog frequency is limited by maximum operation frequency and lower frequency limit. When the jog function is enabled, other operating command will not be accepted and the acceleration time of jog frequency is determined by acceleration time IV. After the jog button is released, inverter will immediately stop output. When realizing the jog function, please set any one of corresponding 6-way programmable terminals as 07 or 08.

Jog function is only valid under shutdown status but invalid during running.

Refer to F044-F049 for relevant parameters.

| F043 | Setting range | Unit | Ex-factory value | Alteration |
|------|---------------|------|------------------|------------|
|------|---------------|------|------------------|------------|

|              |             |      |     |   |
|--------------|-------------|------|-----|---|
| S curve time | 0.0~6500.0s | 0.1s | 0.0 | □ |
|--------------|-------------|------|-----|---|

This parameter is used to set the soft start or soft stop without impact during start or stop of inverter; when S curve is started, the inverter will make the acceleration/deceleration curves with different speed as per the acceleration/deceleration time. Refer to Figure 6-6 for S curve time description.

When F043 is set as zero, S curve is invalid, i.e it will accelerate and decelerate in a straight line, irrespective of stalling situation, this parameter will be valid when F014 is smaller than F043 provided that the actual acceleration is  $(F014+F043)/2$ .

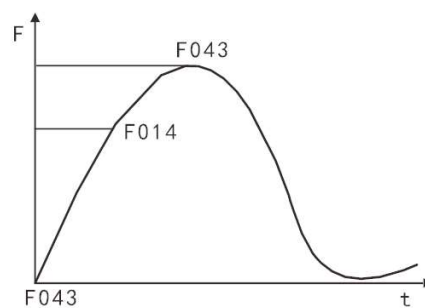

Figure 6-6 S Curve Time

### 6.3 Functional parameter of input/output terminals

| F044                 | Setting range | Unit | Ex-factory value | Alteration |
|----------------------|---------------|------|------------------|------------|
| X1 terminal function | 00~32         | 1    | 02               | □          |
| F045                 |               |      | 03               |            |
| X2 terminal function |               |      | 14               |            |
| F046                 |               |      | 22               |            |
| X3 terminal function |               |      | 23               |            |
| F047                 |               |      | 24               |            |
| X4 terminal function |               |      |                  |            |
| F048                 |               |      |                  |            |
| X5 terminal function |               |      |                  |            |
| F049                 |               |      |                  |            |
| X6 terminal function |               |      |                  |            |

01: RUN (running, & can form several control mode in combination with other terminals.)

02: FOR (forward rotating)

03: REV (reverse rotating)

04: STOP (stopping)

05: FOR/REV (forward/reverse switching, which may also be enabled through three-wire connection. Refer to the following text for details.)

06: JOG (jog)

07: Jog forward, with related parameters of F020, F021, F042.

08: Jog reverse, with related parameters of F020, F021, F042.

09: External control timer 1 start

10: External control timer 2 start

Upon contact closure, the timer is started to time. When time is over, multi-functional output point will be actuated.

11: Set forced frequency switching as F003.

12: In case radiator or motor is overheating, this contact shall be used for detection to protect motor and inverter.

---

13: Emergency cut-off may receive external fault signals such as emergency stop.

14: Reset can be used after fault elimination.

15 ~ 16: Reserve

17: Acceleration/deceleration time selection I

18: Acceleration/deceleration time selection II

Four selections of acceleration/deceleration time for inverter are given here.

19: Multi-segment speed I

20: Multi-segment speed II

21: Multi-segment speed III (16-segment speed can be set with multi-segment speed I, II, III and IV.)

22: High speed

23: Medium speed

24: Low speed

Combination of high, medium and low speed can enable three running modes with different frequency, wherein high-end signal prevails. Three kinds of speed are respectively determined by frequency II, III and IV.

25: PID is allowed to close; PID function is enabled and is allowed to be only effective during running.

26: Multi-segment speed IV

27: UP function

28: DOWN function

Upon actuation of this terminal, inverter frequency will increase or decrease for one unit. When switch is retained, frequency will uniformly change after rapidly increasing or decreasing to some extent. Altered frequency can be memorized or not based on parameter selection in case of power failure and recover.

29: Draft allowance (Draft actuation is allowed upon triggering of this contact.)

31: Pulse counter (This terminal can receive pulse signals not more than 250Hz and make counting after being set as counter.)

32: Counter reset (Actuation of this contact will make current count value

eliminated, with "C00" showed and recounting conducted.)

#### □ Three-wire connection

Three multi-functional terminals shall be used for three-wire connection to enable switching between forward and reverse rotating, which is widely used for optoelectronic switch and other cases, as shown in Figure 6-7.

##### ( 1 ) Button description

- B1: Forward Button (normally open), with effective edge
- B2: Reverse Button (normally open), with effective edge
- B3: Stop Button (normally closed), with effective edge

##### ( 2 ) Parameter set

- F001=1 under external terminal control
- F044=02 X1 is set as forward function
- F045=03 X2 is set as reverse function
- F046=04 X3 is set as stop function

##### ( 3 ) Actuation description

- Triggering of X1 enables inverter forward (start);
- Triggering of X2 enables inverter reverse;
- Disconnection of normally closed button B3 enables inverter stop.

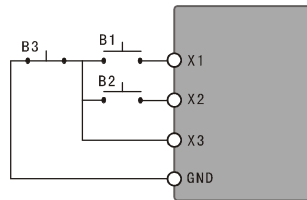

Figure 6-7 Three-wire Wiring Diagram

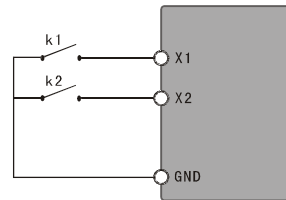

Figure 6-8 Two-wire Wiring Diagram

#### □ Two-wire connection

Enable start, stop, forward/reverse switching, as shown in Figure 6-8. K1, K2 refer to effective level.

(1) Parameter set: F001=1(external terminal control), F044=01(X1 is set as RUN function), F045=05(X2 is set as FOR/REV switching function). Upon closing of K1, inverter runs in a

free way. Inverter runs in a forward way when K2 is disconnected and in a reversed way when K2 is closed.

(2) Parameter set: F001=1(external terminal control), F044=02(X2 is set as forward function), F045=03(X2 is set as reverse function). Upon closing of K1, inverter runs in a forward way and runs in a reverse way when K2 is closed.

□ **Acceleration/deceleration time selection I & II**

| X4 terminal | X5 terminal | Result                             |
|-------------|-------------|------------------------------------|
| OFF         | OFF         | Acceleration/deceleration time I   |
| ON          | OFF         | Acceleration/deceleration time II  |
| OFF         | ON          | Acceleration/deceleration time III |
| ON          | ON          | Acceleration/deceleration time IV  |

[Description] 1) This function is enabled when F080 is set as 0, 2 and 3 and disabled upon disturbed and internally controlled multi-segment speed;

2) Four selections of acceleration/deceleration are available with combination of any two multi-function input terminals;

3) Related multi-function input terminals are set as acceleration/deceleration time selection I and II. Take terminals X4 and X5 for example. If F047 of terminal X4 is set as 17 and F048 of terminal X5 is set as 18, then acceleration/deceleration time selection I and II are enabled for terminals X4 and X5 respectively.

□ **Function of high, medium and low speed terminals**

| RUN | X6     | X5     | X4  | Result  |
|-----|--------|--------|-----|---|
| ON  | OFF    | OFF    | OFF | Main speed, with set value of F003 as the frequency |
| ON  | ON     | OFF    | OFF | Low speed, with set value of F086 as the frequency  |
| ON  | ON/OFF | ON     | OFF | Medium speed, with set value of F087 as the         |
| ON  | ON/OFF | ON/OFF | ON  | High speed, with set value of F088 as the frequency |

[Description] 1) This function is only enabled when F080 is set as 2, i.e. externally controlled 4-segment speed is effective;

2) Acceleration/deceleration time is determined through acceleration/deceleration selection terminal;

3) In case of simultaneous signals from high, medium and low speed, priority shall be given as per the sequence of high, medium and low speed.

□ UP and DOWN functions

| UP  | DOWN | Result                     |
|-----|------|----------------------------|
| ON  | OFF  | Frequency up               |
| OFF | ON   | Frequency down             |
| ON  | ON   | Frequency remains the same |

- [Description] 1) UP and DOWN functions are only enabled when the frequency source is under keyboard operation, i.e. P002 is 0.  
 2) UP and DOWN functions are effective during running and the frequency cannot be changed during standby.  
 3) Operating frequency will not rise when it reaches the maximum.  
 4) Operating frequency will not decrease when it reaches the minimum or lower limit.  
 5) When UP and DOWN functions are adopted, up and down speed shall be dependent on current acceleration/deceleration time.  
 6) If UP or DOWN is long pressed, the frequency will rapidly increase or decrease to some extent and then increase or decrease uniformly.  
 7) The value modified through UP or DOWN through setting of F077 and F117, make sure stop memory or power fault memory function.

□ Description of counter function

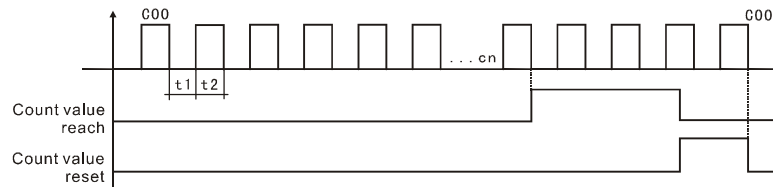

Figure 6-9 Description Diagram of Counter Function

- [Description] 1) Trigger signal duration shall not be lower than 2ms ( $t_1, t_2 \geq 2\text{ms}$ )  
 2) Count value reach is corresponding to actuation of multifunctional output contact.  
 3) Recounting may be conducted only after the counter is reset;  
 4) The counter will stop counting upon 65535.

| F050               | Setting range | Unit | Ex-factory value | Alteration |
|--------------------|---------------|------|------------------|------------|
| Y1 output function | 00~32         | 1    | 01               | □          |
| F051               |               |      | 05               |            |
| Y2 output function |               |      | 00               |            |
| F052               |               |      |                  |            |

|   |  |  |    |  |
|---|--|--|----|--|
| Output function of terminals KA             |  |  |    |  |
| F053  |  |  | 03 |  |
| Output function of terminals<br>FA, FB & FC |  |  |    |  |

|   |  |
|---|--|
| 01: Indications during running  | Contact is enabled in case of output or running indication from inverter.  |
| 02: Zero-speed indication   | Contact is enabled if output frequency is less than start-up frequency.  |
| 03: Fault indication  | Contact is enabled in case inverter is abnormal.   |
| 04: DC braking indication   | Contact is enabled if inverter is under DC braking condition.  |
| 05: Set frequency reaching indication   | Contact is enabled if output frequency reaches set frequency.  |
| 06: Underway acceleration indication  | Contact is enabled if inverter is under accelerating condition.  |
| 07: Underway deceleration indication  | Contact is enabled if inverter is under decelerating condition.  |
| 08: Frequency consistency I arrival indication                                  | Contact is enabled if output frequency reaches designated frequency (F60).   |
| 09: Frequency consistency II arrival indication                                 | Contact is enabled if output frequency reaches designated frequency (F61).   |
| 10: Motor overload warning indication   | Contact is enabled if motor overload is detected by the inverter.  |
| 11: Torque rich detection indication  | Contact is enabled if torque rich is detected by the inverter.   |
| 12: Inverter overload warning indication  | Contact is enabled if overload is detected by the inverter.  |
| 13: Pulse set counter reaching indication                                       | Contact is enabled if count value reaches set value (F065) when external counter is executed.  |
| 14: Pulse medium counter reaching indication                                    | Contact is enabled if count value reaches set value (F066) when external counter is executed.  |
| 15: External control timer I reaching indication                                | Contact is enabled if timer I reaches set value.   |
| 16: External control timer II reaching indication                               | Contact is enabled if timer II reaches set value.  |
| 17: Low voltage warning indication  | Contact is enabled if low voltage is detected by the inverter.   |
| 18: Stage completion indication for internally controlled multi-segment speed   | Contact is enabled and one pulse is output after each stage is completed under programming operation of the inverter.                          |
| 19: Process completion indication for internally controlled multi-segment speed | Contact is enabled and one pulse is output after all stages are completed (i.e. after one circle) under programming operation of the inverter. |
| 20: 4-20mA disconnection  | Contact is enabled if AI input signal is disconnected and F070   |



|  |   |
|--|---|
| indication                                     | is more than 2.   |
| 21-24: Reserve                                 |   |
| 25: Actuation indication of auxiliary pump 1   | Contact controls start-up and stop of the auxiliary pump. Refer to description of multi-pump operation for details. |
| 26: Actuation indication of auxiliary pump 2   |   |
| 27: Draft completion indication                | Contact is enabled when draft is completed and it will automatically reset when the inverter stops.                 |
| 28: PID lower limit warning indication         | Contact is enabled if PID feedback quantity is less than the lower limit (F162).                                    |
| 29: PID upper limit warning indication         | Contact is enabled if PID feedback quantity is more than the upper limit (F161).                                    |
| 30: Braking resistor actuation indication      | Contact is enabled if the inverter is under operation and DC voltage is higher than braking voltage.                |
| 31: Electromagnetic relay actuation indication | Corresponding contact is enabled when contactor pulls in.   |
| 32: Fan actuation indication                   | Corresponding contact is enabled when the inverter temperature rises or the inverter is running.                    |

| F054               | Setting range | Unit | Ex-factory value | Alteration |
|--------------------|---------------|------|------------------|------------|
| A0 output function | 0~3           | 1    | 0                | □          |

Digit frequency output terminal outputs pulse quantity or 0-10V analog quantity. In combination with F055, it can be used for external monitoring after being connected to corresponding instruments with range under 10V.

- 0: 0-10V analog quantity output, corresponding to output frequency, 0-10V corresponding to 0-maximum operation frequency
- 1: 0-10V analog quantity output, corresponding to output current, 0-10V corresponding to 0-two times of rated current of the inverter
- 2: Analog quantity output, corresponding to DC bus voltage, 0-10V corresponding to 0-1000V
- 3: Analog quantity output, corresponding to output AC voltage, 0-10V corresponding to 0-510V/255V

| F055              | Setting range | Unit | Ex-factory value | Alteration |
|-------------------|---------------|------|------------------|------------|
| A0 analogy output | 0~100%        | 1%   | 100              | □          |

This parameter can be used to adjust output voltage of analog terminal so as to adapt to frequency instrument with different range and to calibrate the instruments. It can also be used for calibration if a revolution meter with a range of 0-5V is connected to display operating frequency through multi-functional terminals, with F055 set as 50.

| F056                | Setting range | Unit  | Ex-factory value | Alteration |
|---------------------|---------------|-------|------------------|------------|
| Hopping frequency 1 | 0.0~1000.0 Hz | 0.1Hz | 0.0              | □          |

|                         |               |       |     |  |
|-------------------------|---------------|-------|-----|--|
| F057                    |               |       |     |  |
| Hopping frequency 2     |               |       |     |  |
| F058                    |               |       |     |  |
| Hopping frequency 3     |               |       |     |  |
| F059                    | 0.10~10.00 Hz | 0.1Hz | 0.5 |  |
| Hopping frequency range |               |       |     |  |

To avoid mechanical resonance point, these three frequency hopping points are set. The actual hopping frequency range is two times that of F059 and all hopping frequency will be invalid when F059=0, as shown in Figure 6-10.

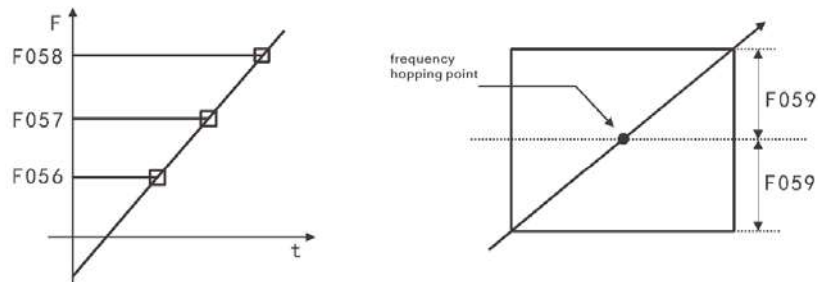

Figure 6-10 Frequency Hopping

| F060   | Setting range | Unit    | Ex-factory value | Alteration |
|--|---------------|---------|------------------|------------|
| Frequency consistency I<br>(constant pressure water<br>supply high speed<br>frequency)   | 0.0~1000.0 Hz | 0.01 Hz | 0.0              | □          |
| F061   |               |         |                  |            |
| Frequency consistency<br>II(constant pressure water<br>supply lower speed<br>frequency)) |               |         |                  |            |
| F062   | 0.1~10.0 Hz   | 0.1 Hz  | 0.5              |            |
| Frequency consistency range  |               |         |                  |            |

When output frequency is more than consistent frequency, corresponding multi-functional output terminal is enabled, with consistent frequency range as a hysteresis loop. When the inverter is used for constant-pressure water supply, F060 is used as high-speed frequency and F061 is set as low-speed frequency.

| F063                                  | Setting range | Unit | Ex-factory value | Alteration |
|---------------------------------------|---------------|------|------------------|------------|
| Time set of external control timer I  | 0.1~10.0s     | 0.1s | 0.1              | ∅          |
| F064                                  | 1~100s        | 1s   | 1                | ∅          |
| Time set of external control timer II |               |      |                  |            |

External control timer I is a timer of 0.1S-10.0s and external control timer II is of 1s-100s. When multi-functional input terminal timer opens or closes, the timer starts to time; when the timer reaches, corresponding multi-functional output contact is enabled; when the timer disconnects, multi-functional output terminal timer resets. During operation, the timer will continue timing normally in spite of stop due to fault and will reset automatically in case of stop due to power failure.

| F065                     | Setting range | Unit | Ex-factory value | Alteration |
|--------------------------|---------------|------|------------------|------------|
| Pulse count value set    | 0~65500       | 1    | 0                | ∅          |
| F066                     | 0~65500       | 1    | 0                | ∅          |
| Pulse medium counter set |               |      |                  |            |

6-way multi-function input terminals can be used as trigger terminal of the counter. When count value reaches the set value F065, corresponding multi-function output contact is enabled. After zero clearing, the counter resets to enable recounting. Proximity switch and optoelectronic switch can be used for trigger signal.

| F067  | Setting range | Unit | Ex-factory value | Alteration |
|---|---------------|------|------------------|------------|
| Positive and negative logic of digital input terminal | 0~1           | 1    | 0                | ∅          |

0: Positive logic, with NPN as wiring mode      1: Negative logic, with PNP as wiring mode

It shall be used together with Jumper J2. In case of NPN as the external wiring mode, J2 jumps to NPN, with F067 set as 0; in case of PNP as the external wiring mode, J2 jumps to PNP, with F067 set as 1.

| F068                                     | Setting range | Unit | Ex-factory value | Alteration |
|--|---------------|------|------------------|------------|
| Digital input dithering elimination time | 0~60000ms     | 1    | 20               | ∅          |